

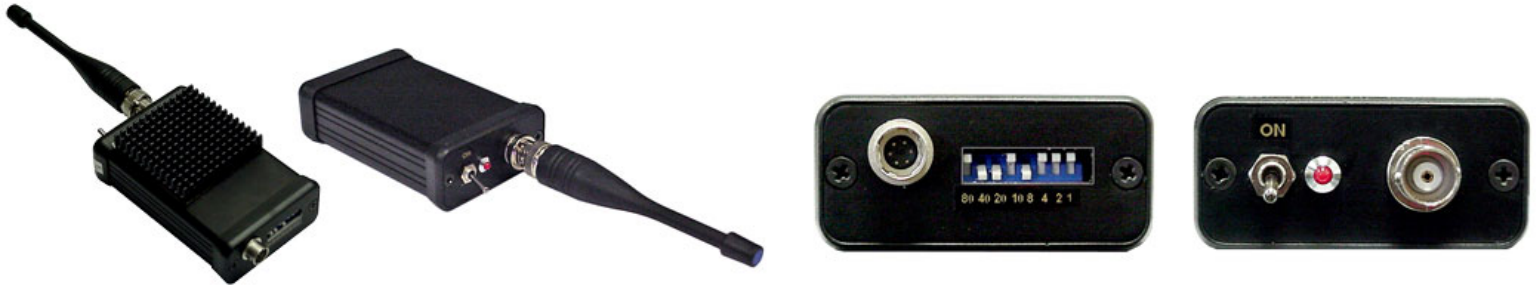

# GX-68P VIDEO SENDER FOR ALL TV CHANNELS



This is a new UHF Professional Video sender for any TV channel from CH 14 UHF to CH 69 UHF Air TV band and all UHF cable channels. This video sender is designed for professionals in Film industry and TV productions. This unit out performs all kinds of video senders on the market! Range is up to 600 ft line-of-sight using our tuner M-806 and High-gain antennas, over 1 km with a high power unit. This sender has excellent color picture quality with a built-in video filter and amplifier for excellent color quality. The video sender was built in a solid metal box and the unit measures: 3.2" X 2" X 0.9". It is easy to change the channel by dip switches on the back panel. This video sender is an NTSC model. Power supply is 12 V battery pack or Anton - Bauer battery 14.6 V – 32 V. This unit uses a professional Hirose connector.

Models:

**GX-68** low power version    **GX-68/H** high power version

Technical Specifications	
operating Frequencies:	470 MHz- 806 MHz
Channel:	TV channels 14-69 UHF AIR + cable UHF channels
DC Voltage:	12 V- 32 V
RF power:	250 mW med. power version (650 mW high power version)
Minimum required voltage:	12 V
Battery power:	12 V - 32 V
Frequency stability:	+20 ppm
Video distortion:	2%
Maximum range:	From 600 ft - 1 km with special antenna
Video Format:	PAL, NTSC
Current Consumption:	310 mA / 12 V med. power unit, 650 mA high power unit
Antenna:	Rubber ducky included
Antenna Connector:	BNC
Impedance:	50 ohms
Video Connector:	<b>Hirose</b> professional connector
Video Impedance:	75 ohms
Audio level:	300 mV
Video level:	1 V
Temperature Range:	-15 +65* C
Dimensions:	3.2" X 2 " X 0.9 "
Weight:	80 grams (100 grams)
Modulation:	Negative AM

# Video Characteristics

Parameter	Test Conditions	Min	Typ	Max	Unit
Video bandwidth	Reference 0 dB at 100 KHz, measured at 5 MHz.	-1.5	-0.8	—	dB
Video input level	75 Ohm load	—	—	1.5	Vcvbs
Video input current		—	0.2	1	μA
Video input impedance		500	—	—	KΩ
Peak White Clip	PWC bit set to 1.	110	114	118	%
Video S/N	Using CCIR Rec. 567 weighting filter	50	53	—	dB
	Unweighted .	45	—	—	
Differential Phase	CCIR Test Line 330, worst case from the first 4 steps out of 5.	-5	—	5	deg
Differential Gain	CCIR Test Line 310, worst case from the first 4 steps out of 5.	-5	—	5	%
Luma/Sync ratio	Input ratio 7.0:3.0	6.8/ 3.2	—	7.2/ 2.8	—
Video modulation depth		75	81	88	%

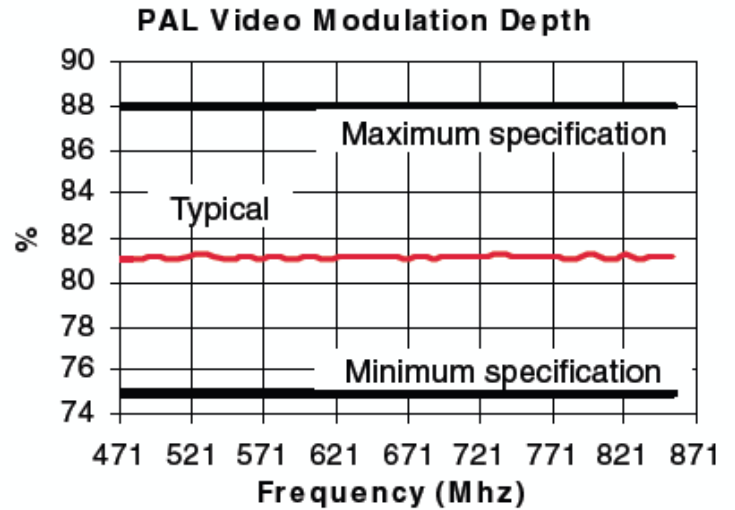
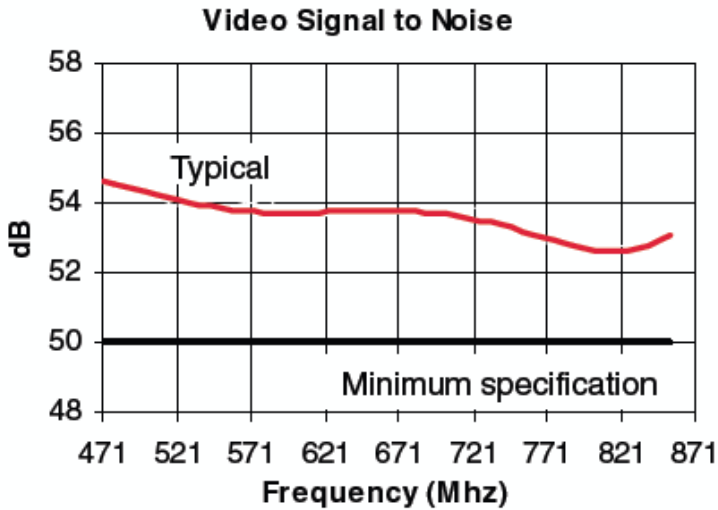

Typical performances

# Audio Characteristics

Parameter	Test Conditions	Min	Typ	Max	Unit
Picture-to-Sound ratio		13.9	16.12	19.15	dB
Audio modulation depth	FM modulation: Fs=5.5, 6 or 6.5 MHz 100% modulation= $\pm 50$ KHz FM deviation	—	80	—	%
	FM modulation: NTSC Fs=4.5 MHz 100% modulation= $\pm 25$ kHz FM deviation	—	80	—	%
Audio input resistance		45	53	61	K $\Omega$
Audio Frequency response	Reference 0 dB at 1 KHz, using specified pre-emphasis circuit, measure from 50Hz to 15 KHz	-2.5	—	+2	dB
Audio Distortion FM (THD only)	at 1 KHz, 100% modulation ( $\pm 50$ KHz) No video	—	0.4	2	%
Audio S/N with Sync Buzz FM		48	53	—	dB

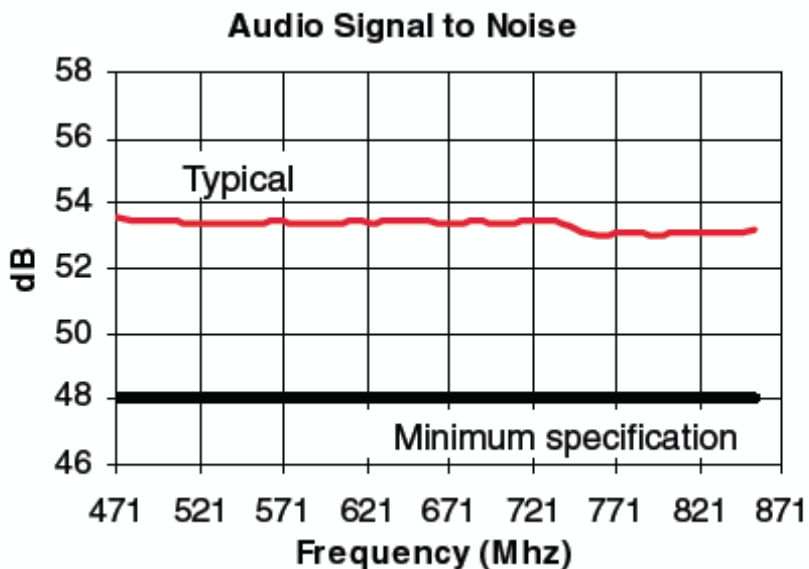

Typical performances

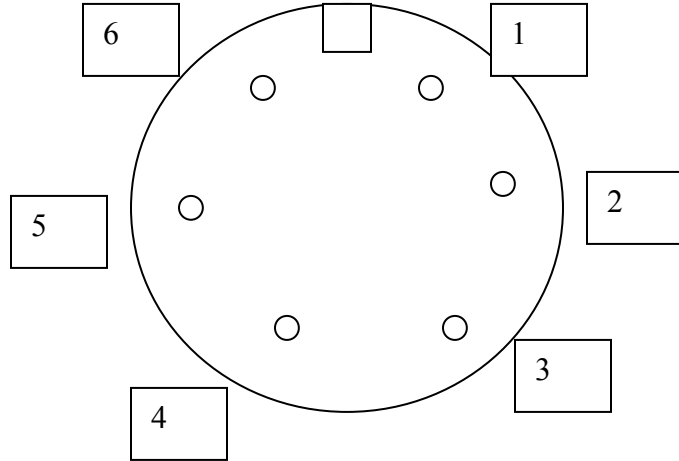

**PIN LAYOUT, HIROSE CONNECTOR:**

1. GROUND – (NEGATIVE)
2. VIDEO INPUT
3. +Vcc 12 V to 32 V
4. AUDIO INPUT
5. N/C
6. N/C

# GX-68 Video Sender Drawing

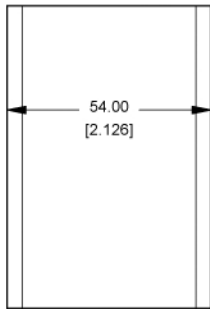
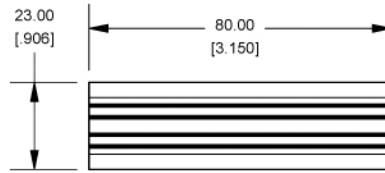
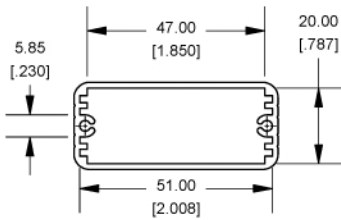

## Slot Details

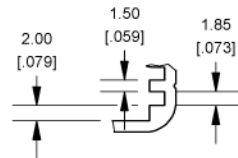

## End Plate

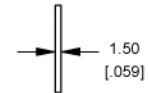
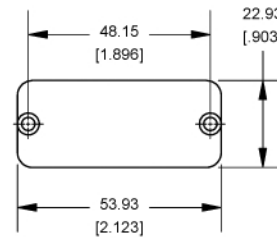

## Open Bezel

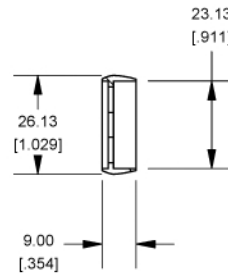
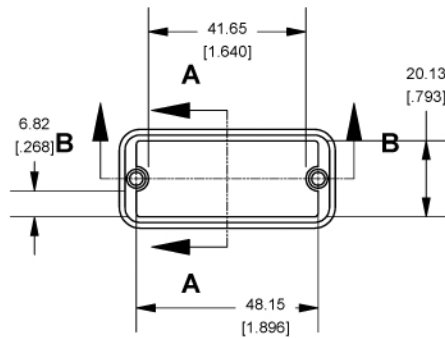

## SECTION A-A SCALE 1 / 2

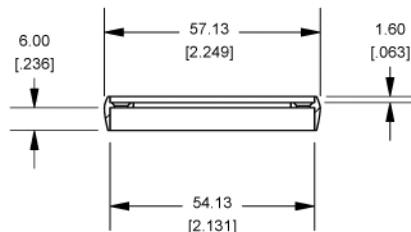

## SECTION B-B SCALE 1 / 2